

# 1000mm base cabinet

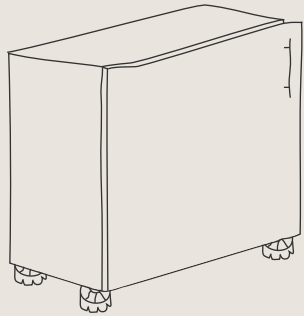

## equipment required

- **Cordless drill**
- **Drill bits:**  
No 2 screw tip, 4mm bit, No 12 countersinking bit
- **65mm wood screw**
- **Wall fixing** (only if fixing cabinet to wall)
- **Tape measure**
- **Adjustable square**
- **Spirit level**
- **Quick release clamps**
- **Pencil**
- **Safety gear:**  
Safety glasses, ear muffs, dust mask

## important tips

- Plumbing and electrical work must be carried out by a licenced trades person.
- Assemble on a soft surface to ensure the cabinetry doesn't get scratched.
- Wear appropriate safety gear during assembly.
- To securely mount the cabinets on a stud wall, use at least 8-gauge screws that are 65mm in length. However, if your wall is made of concrete, brick, or a different material, consult with an expert to determine the appropriate fastening method.
- Remove any protective wrapping before getting started

# assembly instructions

## included materials

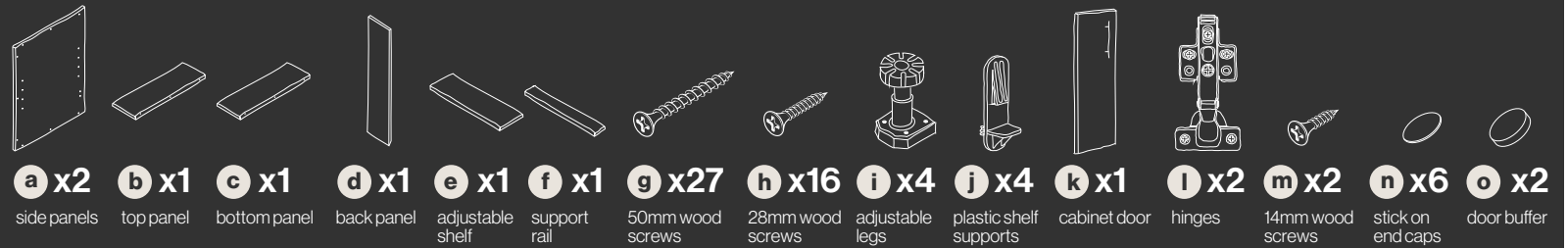

## step 1

## cabinet assembly

**1**

Attach the back panel (**d**) and bottom panel (**c**) using 50mm wood screws (**g**).

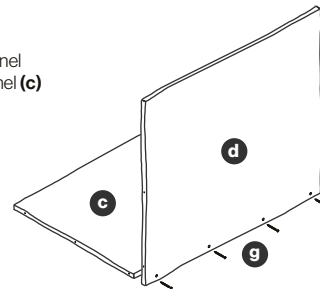

**2**

Attach the two side panels (**a**) to the back and bottom panels using 50mm wood screws (**g**).

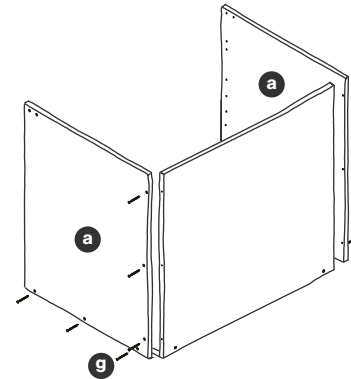

**3**

Attach the support rail (**f**) using 50mm wood screws (**g**).

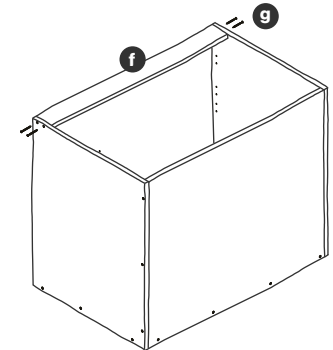

**4**

Locate the 2 groups of pre-drilled holes on the bottom panel & attach all adjustable leg plates (**i**) using 28mm wood screws (**h**).

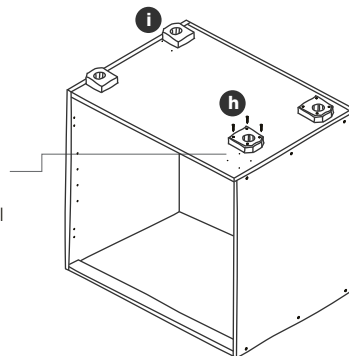

**5**

Attach both legs (**h**) to the plates and adjust the height of the legs to 145mm.

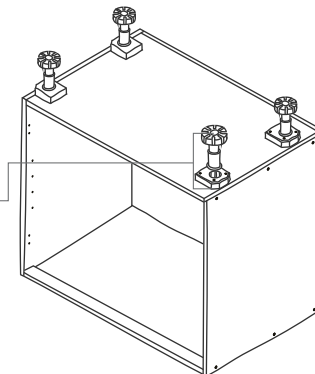

**6**

a. Turn your cabinet upright and insert the 4 plastic shelf supports (**j**) at your desired shelf height.  
b. Slide the shelf (**e**) into position, resting on the supports.

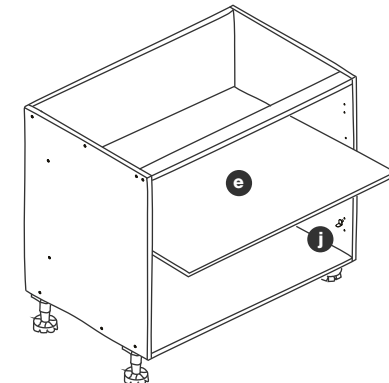

## step 2

### joining the cabinets

**1**

Check your cabinets are level.

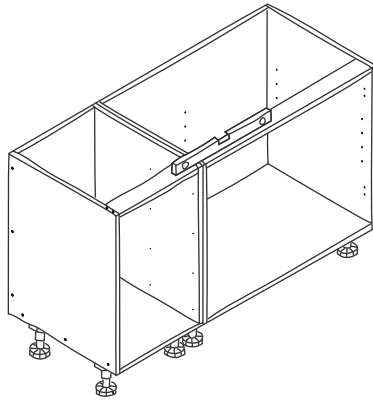

**2**

Clamp cabinets using quick release clamps. Once secured, pre-drill screw holes.

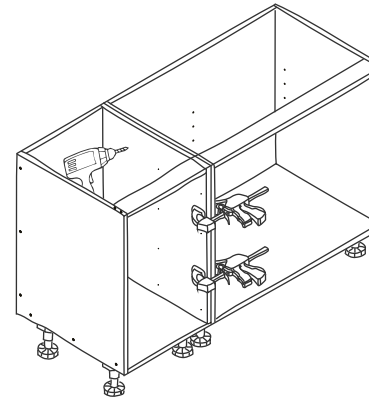

**3**

Attach the cabinets together using using 28mm wood screws (**h**).

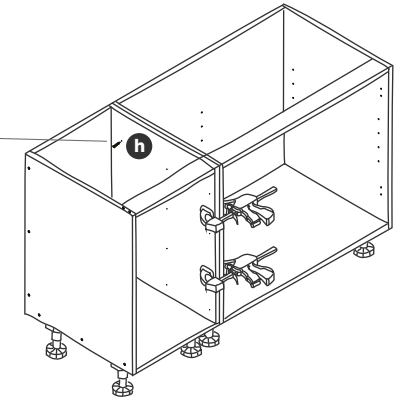

## step 3

### securing cabinets to wall

**1**

Check again that all of your cabinets are level. If you have a plasterboard wall, attach cabinets using timber screws that are at least 65mm in length. Ensure each screw is inserted through a timber stud.

If your walls are made of another material eg, brick, concrete, steel etc, obtain professional advice on the best way to safely attach your cabinets.

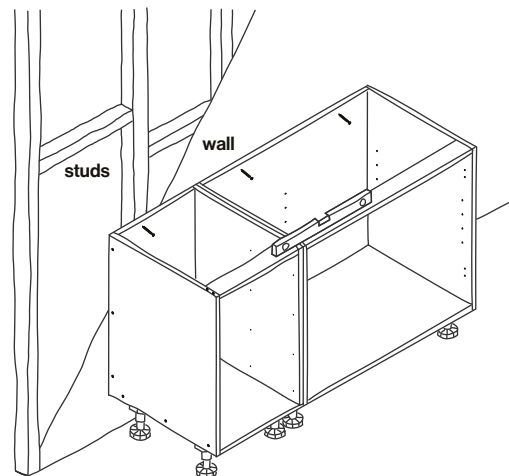

## step 4

### attaching the door

**1**

- Clip the hinge plates onto the door panel
- Push down to clip hinge together securely
- Adjust the screws to align the doors and add extra screws once door is positioned correctly.

