

# 150mm wall cabinet

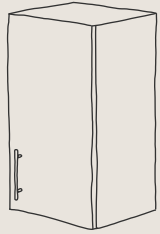

## equipment required

- **Cordless drill**
- **Drill bits:**  
No 2 screw tip, 4mm bit, No 12 countersinking bit
- **65mm wood screw**
- **Wall fixing** (only if fixing cabinet to wall)
- **Tape measure**
- **Adjustable square**
- **Spirit level**
- **Quick release clamps**
- **Cabinet supports**
- **Pencil**
- **Safety gear:**  
Safety glasses, ear muffs, dust mask

## important tips

- Plumbing and electrical work must be carried out by a licenced trades person.
- Assemble on a soft surface to ensure the cabinetry doesn't get scratched.
- Wear appropriate safety gear during assembly.
- To securely mount the cabinets on a stud wall, use at least 8-gauge screws that are 65mm in length. However, if your wall is made of concrete, brick, or a different material, consult with an expert to determine the appropriate fastening method.
- Remove any protective wrapping before getting started

# assembly instructions

## included materials



## step 1

## cabinet assembly

1

Attach the top panel (**b**) and bottom panel (**c**) to one of the side panels (**a**) using 50mm wood screws (**e**).

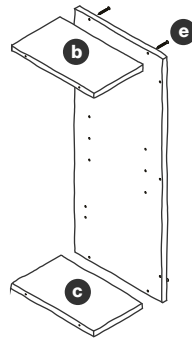

2

Attach the remaining side panel (**a**) to the top and bottom panels using 50mm wood screws (**e**).

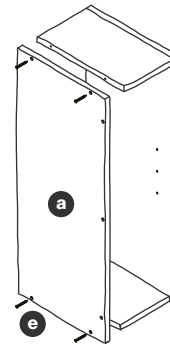

3

Attach the back panel (**d**) using 50mm wood screws (**e**).

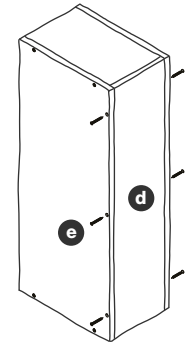

4

Insert the 4 plastic shelf supports (**k**) at your desired shelf height.

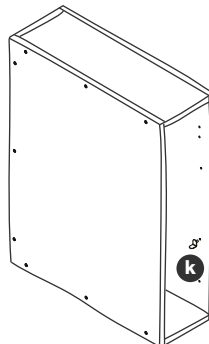

5

Slide the shelf (**g**) into position, resting on the supports.

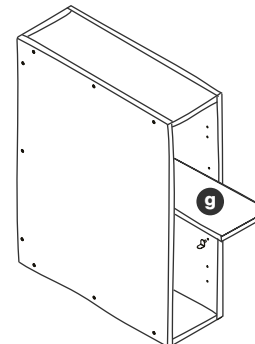

## step 2 joining the cabinets and securing to the wall

**1**

Using cabinet supports, align the cabinets and hold together using quick release clamps.

Ensure the cabinets are level.

**Tip:** It may be best to align the top of the cabinets with the top of your pantry.

**Note:** AUS/NZ standards requires a minimum distance of 600mm between burners and the rangehood.

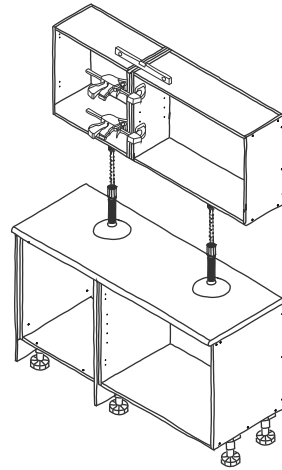

**2**

Check again that all of your cabinets are level. If you have a plasterboard wall, attach cabinets using timber screws that are at least 65mm in length. Ensure each screw is inserted through a timber stud.

If your walls are made of another material eg. brick, concrete, steel etc, obtain professional advice on the best way to safely attach your cabinets.

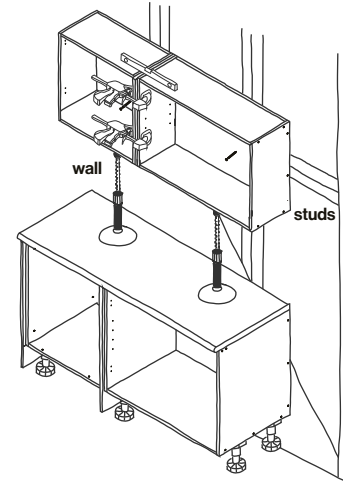

## step 3 attaching the door

**1**

- Clip the hinge plates onto the door panel
- Push down to clip hinge together securely
- Adjust the screws to align the doors and add extra screws once door is positioned correctly.

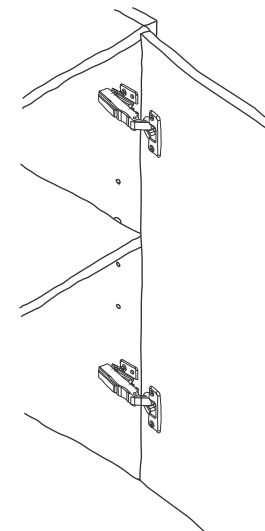
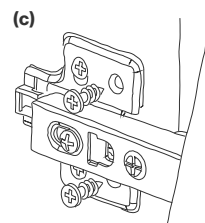
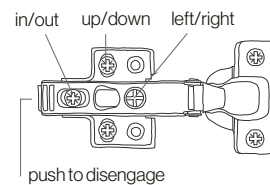
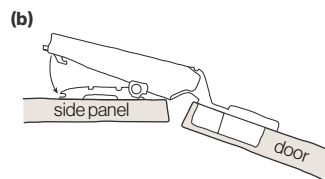
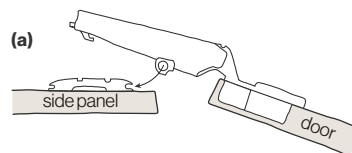

## ! care instructions

Your Trendstyle cabinets are crafted from high-quality materials to ensure longevity, provided that proper care and maintenance are observed.

When cleaning your cabinets, it is essential to use a non-abrasive cleaner and avoid materials such as steel wool or abrasive items that may cause scratches and damage. Harsh chemicals or thinner-based products should be avoided as they can harm the melamine surfaces.

While our cabinets are resistant to water, they are not completely waterproof, so it's important to use only damp cleaning cloths, avoiding saturation. Promptly address any large spills of water that may occur. We have a dedicated customer service line available to provide assistance and answer any inquiries you may have regarding our products.