

900mm wall cabinet

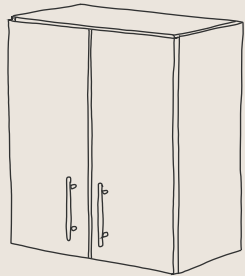

equipment required

- Cordless drill
- Drill bits:
No 2 screw tip, 4mm bit, No 12 countersinking bit
- 65mm wood screw
- Wall fixing (only if fixing cabinet to wall)
- Tape measure
- Adjustable square
- Spirit level
- Quick release clamps
- Cabinet supports
- Pencil
- Safety gear:
Safety glasses, ear muffs, dust mask

important tips

- Plumbing and electrical work must be carried out by a licenced trades person.
- Assemble on a soft surface to ensure the cabinetry doesn't get scratched.
- Wear appropriate safety gear during assembly.
- To securely mount the cabinets on a stud wall, use at least 8-gauge screws that are 65mm in length. However, if your wall is made of concrete, brick, or a different material, consult with an expert to determine the appropriate fastening method.
- Remove any protective wrapping before getting started

assembly instructions

included materials



step 1 cabinet assembly

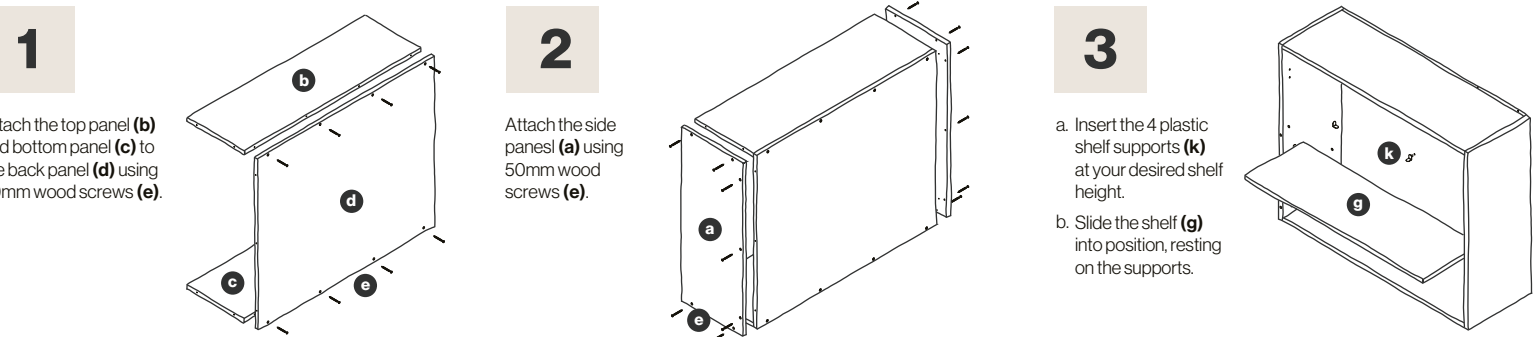

step 2 joining the cabinets and securing to the wall

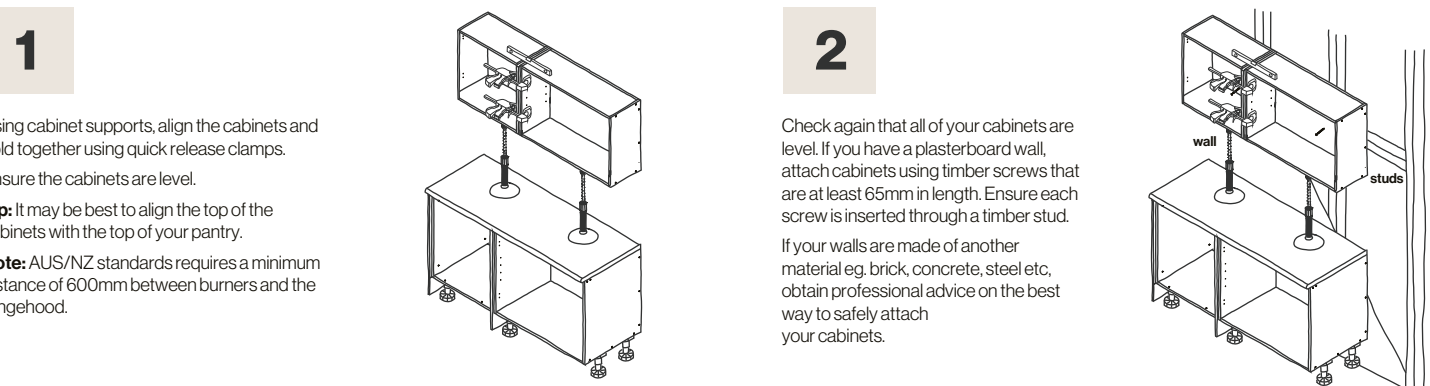

step 3

attaching the door

1

- a. Clip the hinge plates onto the door panel
- b. Push down to clip hinge together securely
- c. Adjust the screws to align the doors and add extra screws once door is positioned correctly.

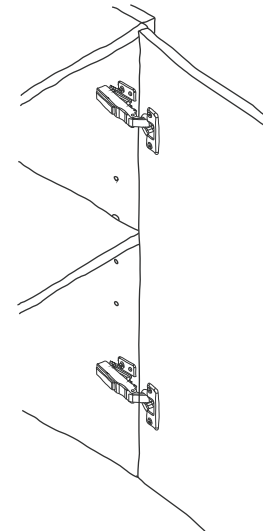
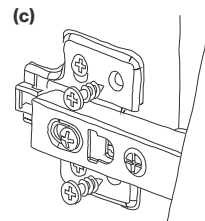
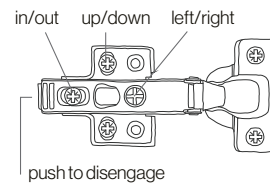
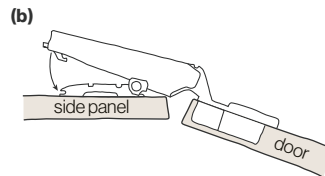
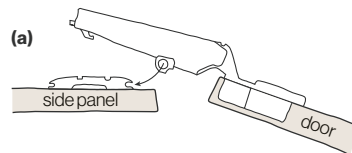

! care instructions

Your Trendstyle cabinets are crafted from high-quality materials to ensure longevity, provided that proper care and maintenance are observed.

When cleaning your cabinets, it is essential to use a non-abrasive cleaner and avoid materials such as steel wool or abrasive items that may cause scratches and damage. Harsh chemicals or thinner-based products should be avoided as they can harm the melamine surfaces.

While our cabinets are resistant to water, they are not completely waterproof, so it's important to use only damp cleaning cloths, avoiding saturation. Promptly address any large spills of water that may occur. We have a dedicated customer service line available to provide assistance and answer any inquiries you may have regarding our products.